

# PRIBOR G 80

## SPOJNI ČLANCI

### SPOJNICA LANCA VG - EUROPSKI TIP

Šifra	Veličina	Nosivost	A	L	K	D	Težina
	mm	t	(mm)	(mm)	(mm)	(mm)	kg
25201	6-8	1.12	16.2	58	42	7	0.08
25203	7/8-8	2	20.5	79.5	58	8.5	0.145
25204	10-8	3.15	28	93	68	10.8	0.30
25205	13-8	5.3	30	117	90	15	0.70
25206	16-8	8	36.3	93	148	19.8	1.10
25207	18/20-8	12.5	44	117	169.5	24	1.84
25208	22-8	15	51	148	193.5	26	3.20
25209	26-8	21.2	58	154	220	30	4.50
25210	32-8	31.5	67.5	169.5	281	37	9.00

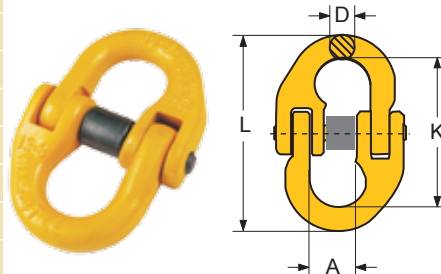

### SPOJNICA LANCA VG - AMERIČKI TIP

Šifra	Veličina (In.)	Nosivost (lbs)	Dimenzije (in.)						Težina (lbs)
			A	B	C	D	E	F	
25221	9/32(1/4)	3500	0.36	1.88	1.75	0.78	0.66	0.56	0.28
25222	5/16	4500	0.39	2.13	1.97	0.88	0.69	0.63	0.33
25223	3/8	7100	0.52	2.50	2.50	1.03	0.88	0.75	0.73
25224	1/2	12000	0.64	3.44	3.22	1.44	1.13	0.94	1.67
25225	5/8	18100	0.75	4.13	3.78	1.73	1.41	1.13	2.86
25226	3/4	28300	0.97	4.94	4.66	2.08	1.63	1.28	5
25227	7/8	34200	1.08	5.50	5.63	2.31	2.00	1.44	7.5
25228	1	47700	1.22	6.10	6.19	2.50	2.25	1.88	11.03
25229	1-1/4	72300	1.50	7.43	7.63	3.06	2.56	2.19	20.38

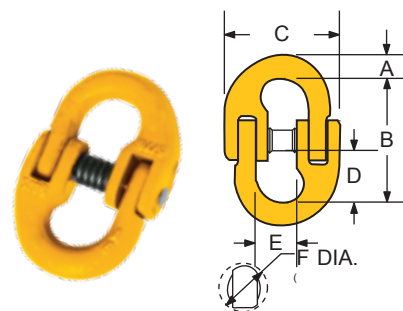

PRIBOR G80

### SPOJNICA POLIESTERSKE PRIVEZNICE

Šifra	Veličina	Nosivost	A	B	K	W	G	E	N.W.
	mm	(T)	(mm)	(mm)	(mm)	(mm)	(mm)	(mm)	(kg)
25211A	6-8	1.12	15	60	56	40	18	7	0.2
25211	7/8-8	2.0	20	61.5	63.7	40	24	9.5	0.3
25212	10-8	3.15	24	66	83	39	30.5	11	0.68
25213	13-8	5.3	28	88	93.7	55	36.8	16.5	1.47
25214	16-8	8	34.5	108	120	65.5	45.2	19.8	2.3
25215	20-8	12.5	41	129	138	80	51.8	23	3.3

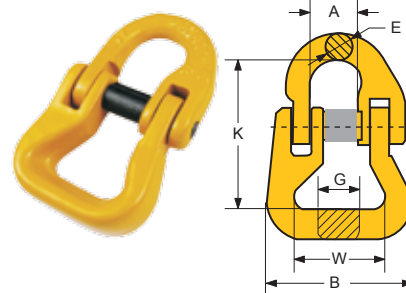

### SPOJNICA LANCA OMEGA

Šifra	Veličina	Nosivost	A	B	Ø	H	L	N.W.
	mm	(T)	(mm)	(mm)	(mm)	(mm)	(mm)	kg
25160	6-8	1.12	8	41	20.5	25	52	0.12
25161	7/8-8	2.0	10	52	23.5	35	68.5	0.22
25162	10-8	3.15	12	62	31.5	40.5	81	0.36
25163	13-8	5.3	15	81	41	54	108	0.71
25164	16-8	8	19	99	49.5	64	126	1.3
25164A	20-8	12.5	23	118	58	75.6	152	2.2

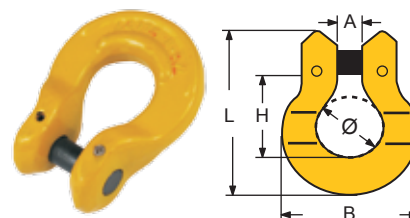

# PRIBOR G 80

## KUKE

### KUKA SA OSIGURAČEM I VG SPOJNICOM

Šifra	Veličina	Nosivost	A	B	C	D	Težina
	mm	(T)	(mm)	(mm)	(mm)	(mm)	
25011	7/8-8	2.0	30	117	83	23	0.6
25012	10-8	3.2	38	149	102	30	0.87
25013	13-8	5.3	48.5	185	126	37	2.26
25014	16-8	8.0	60	230	150.5	43.5	3.7
25015	18/20-8	12.5	67.5	255	180	53	6.2

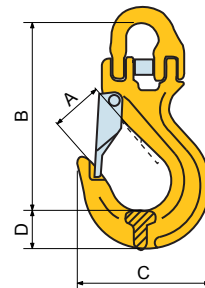

### KUKA SAMOZATVARAJUĆA SA OKOM

Šifra	Veličina	Nosivost	Ø1	R	D	Ø2	H	E	Težina
	mm	(t)	(mm)	(mm)	(mm)	(mm)	(mm)	(mm)	
25001	6-8	1.12	22	110.5	10	34	19.5	28	0.5
25002	7/8-8	2	25	136	12	46	24	34	0.8
25003	10-8	3.15	32	171	15	56	28.5	44	1.55
25004	13-8	5.3	40.5	208.5	19.5	69	40	52	3.2
25005	16-8	8	56	257.5	22	86	50.5	60	5.74
25006	18/20-8	12.5	64.5	275	27	100	55	81	8.5
25007	22-8	15	70	320	30	98	67	82	13
25008	26-8	21.2	80	363	34	110	75	110	18
25009	32-8	31.5	105	472	45	166	97	168	44.5

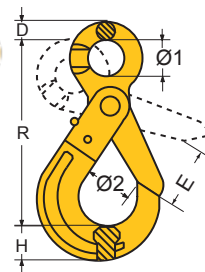

### KUKA SAMOZATVARAJUĆA ZA LANAC

Šifra	Veličina	Nosivost	E	B	H	Ø	R	Težina
	mm	(t)	(mm)	(mm)	(mm)	(mm)	(mm)	
25021	6-8	1.12	29	8.5	19.5	34	95.5	0.5
25022	7/8-8	2	34	9.5	24	46	121	0.8
25023	10-8	3.15	44	12	28.5	56	146	1.5
25024	13-8	5.3	52	15	40	69	182	2.8
25025	16-8	8	60	18	50.5	86	218	5.6
25026	18/20-8	12.5	83	25	55	100	240	7.5
25027	22-8	15	88	25.5	67	98	276.5	11.5
25028	26-8	21.2	95.5	30	75	110	310.5	18.5

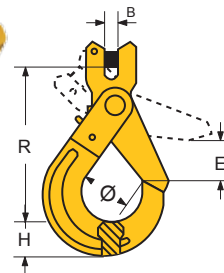

### KUKA SAMOZATVARAJUĆA OKRETNA

Šifra	Veličina	Nosivost	B	C	D	L	T	E	Težina
	mm	(t)	(mm)	(mm)	(mm)	(mm)	(mm)	(mm)	
25041	6-8	1.12	32.5	22	11.25	170	34	29	0.71
25042	7/8-8	2	35.5	26	12.5	210	46	34	1.1
25043	10-8	3.15	42	34	15	247	56	44	2.0
25044	13-8	5.3	50	38.5	16	302	69	52	4.0
25045	16-8	8	61	55	21.5	383	86	60	7.3
25046	18/20-8	12.5	72	61	26	418	100	83	11.6
25047	22-8	15	95	95	33	527	98	88	16.0
25048	26-8	21.2	122	115	42	610	110	95.5	21.5
25049	32-8	31.5	140	146	52	777	166	150	79

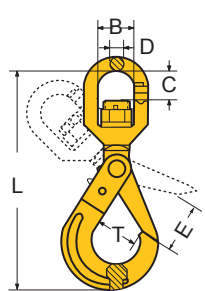

# PRIBOR G 80

## KUKE

### KUKA SA OKOM BEZ OSIGURAČA

Šifra	Veličina	Nosivost	A	D	P	K	H	T	Težina
	mm	(T)	(mm)	(mm)	(mm)	(mm)	(mm)	(mm)	(KG)
25271	6-8	1.12	20	9	28	80	19	16.5	0.30
25272	7/8-8	2	25	11	34	98	24	19.5	0.43
25273	10-8	3.15	38	15	37	120	32	20	1.06
25274	13-8	5.3	43	19	52	153	42	31	2.03
25275	16-8	8	50	23	56	185	48	36	3.13
25276	20-8	12.5	62	24	61	217	58	52	6.40

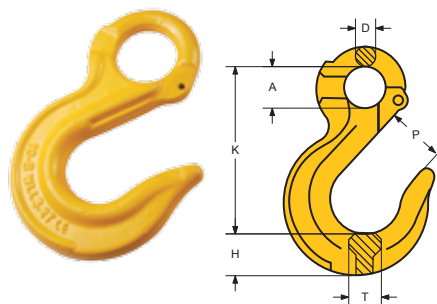

### KUKA SA OKOM I OSIGURAČEM

Šifra	Veličina	Nosivost	Ø1	E	D	Ø	L	Težina
	mm	(t)	(mm)	(mm)	(mm)	(mm)	(mm)	(KG)
25165	6-8	1.12	9	24	21	20	108	0.3
25166	7/8-8	2.0	11	30	26	25	133	0.4
25167	10-8	3.15	15	34	39	38	167	0.9
25168	13-8	5.3	19	39	54	43	213	1.7
25169	16-8	8	23	46	64	50	255	3.2
25170	20-8	12.5	24	40	80	62	305	5.8
25171	22-8	15	32	71	80	62	348	8.5
25172	26-8	21.2	35	81	82	64	394	13
25173	32-8	31.5	37	102	112	88	480	17

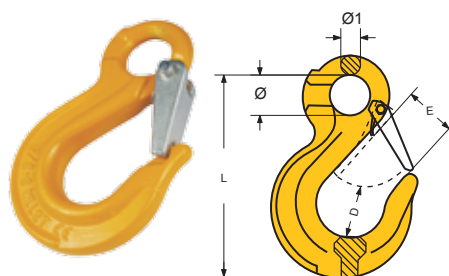

### KUKA ZA LANAC BEZ OSIGURAČA

Šifra	Veličina	Nosivost	K	H	T	P	Težina
	mm	(T)	(mm)	(mm)	(mm)	(mm)	(KG)
25391	6-8	1.12	75	22	15.5	23.5	0.40
25392	7/8-8	2	85	32	19	25	0.64
25393	10-8	3.15	104	35	25.5	34	1.04
25394	13-8	5.3	128	42	29.5	40	1.66
25395	16-8	8	150	52	37.5	45	3.70
25396	20-8	12.5	180	55	51	48	6.04

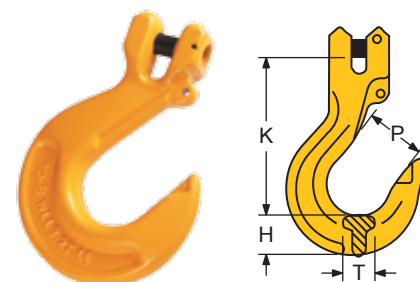

### KUKA ZA LANAC SA OSIGURAČEM

Šifra	Veličina	Nosivost	A	B	Ø	H	K	E	Težina
	mm	(T)	(mm)	(mm)	(mm)	(mm)	(mm)	(mm)	(KG)
25371	6-8	1.12	8	32	35	23	76	26	0.32
25372	7/8-8	2.0	9.5	37	37	32.5	85.5	29	0.52
25373	10-8	3.15	13	49	46	35	104	39	1.05
25374	13-8	5.3	16.5	56.5	56	42.5	128	47	2
25375	16-8	8	21.5	70.5	60	54	150	55	3.7
25376	20-8	12.5	24	77	79	58	180	61	6
25377	22-8	15	27	91	101	62	213	72	10.4

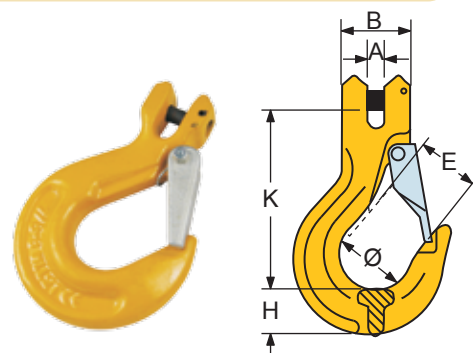

# PRIBOR G 80

## KUKE

### KUKA OKRETNNA SA OSIGURAČEM

Šifra	Veličina	Nosivost	A	E	B	H	K	L	Težina
	mm	(t)	(mm)	(mm)	(mm)	(mm)	(mm)	(mm)	(KG)
25091	6-8	1.12	32	22	22.5	9	112	140	0.34
25092	7/8-8	2	44	26	35	15.8	150	190	1.02
25093	10-8	3.15	44	28	35	15.8	162	206	1.24
25094	13-8	5.3	50	35	39	18	190	242	2.25
25095	16-8	8	64	43	53	25	246	316	4.66
25096	20-8	12.5	70	55	51	28	282	369	7.4
25097	22-8	15	79	61	58	32	332	431	10.6
25098	26-8	21.2	105	81	100	40	431	547	21.4
25099	32-8	31.5	105	82.5	90	40	472	603	32

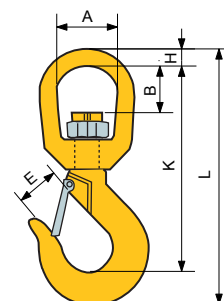

### KUKA ZA SKRAČIVANJE SA OKOM

Šifra	Veličina	Težina	E	Ø	H	R	L	Nosivost
	mm	(T)	(mm)	(mm)	(mm)	(mm)	(mm)	(KG)
25081	6-8	1.12	8	13.5	16	51	75.2	0.14
25082	7/8-8	2	10.8	17	18.5	60.5	88.5	0.245
25083	10-8	3.15	13	20	29	79.5	121.5	0.65
25084	13-8	5.3	16.5	26	42.8	99.7	158	1.39
25085	16-8	8	19.2	30	45.7	104	169	2.2
25086	20-8	12.5	24	37	56	140	219	4.6
25087	22-8	15	28	44	68	165	259	8.2
25088	26-8	21.2	30	44	77	188.5	298	9.8
25089	32-8	31.5	38	57	95	228	361	19.4

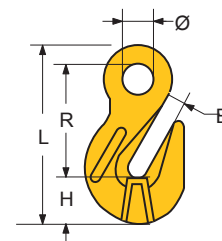

### KUKA ZA SKRAČIVANJE ZA LANAC

Šifra	Veličina	Nosivost	E	A	H	L	Težina
	mm	(T)	(mm)	(mm)	(mm)	(mm)	(KG)
25101	6-8	1.12	8	8	16	75	0.25
25102	7/8-8	2	10.8	9.5	21.6	90	0.32
25103	10-8	3.15	13.5	12.5	30	126	0.73
25104	13-8	5.3	16.5	15	42.5	163	1.6
25105	16-8	8	19.2	19.5	45.5	183.5	2.8
25106	20-8	12.5	24	24	56	219	5
25107	22-8	15	27	27	68.5	254	6.3

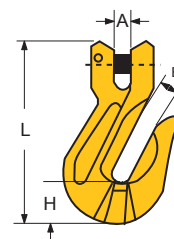

### KUKA ZA SKRAČIVANJE ZA LANAC SA OSIGURAČEM

Šifra	Veličina	Nosivost	A	B	E	M	L	Težina
	mm	(T)	(mm)	(mm)	(mm)	(mm)	(mm)	(KG)
25111	6-8	1.12	8	32	8	43.5	75	0.28
25112	7/8-8	2	9.5	35	11	49.5	89	0.33
25113	10-8	3.15	12.5	42.5	13.2	70.5	126.5	0.88
25114	13-8	5.3	15	53	16.5	90	163.5	1.85
25115	16-8	8	19.5	65.5	19.2	112.5	183.5	3.24

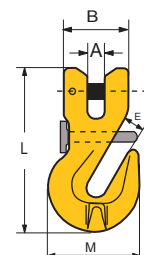

# PRIBOR G 80

## KUKE

### KUKA SA OKOM I OSIGURAČEM

Šifra	Veličina	Nosivost	Ø	E	H	K	L	Težina
	mm	(T)	(mm)	(mm)	(mm)	(mm)	(mm)	(KG)
25121	6-8	1.12	19	22	19	80	110	0.28
25122	7/8-8	2	28	25	25	103	140.5	0.65
25123	10-8	3.15	31	27.5	28	118	162	0.94
25124	13-8	5.3	39	33	35	145	201	1.95
25125	16-8	8	51	40	45	180	256	3.77
25126	20-8	12.5	62	51	57	230	317	6.8
25127	22-8	15	73	57	70	260	360	9.8
25128	26-8	21.2	89	75	76	318	434	16.25
25129	32-8	31.5	90	98	91	360	495.5	27.2

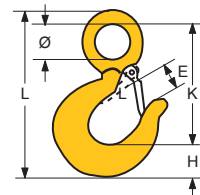

### KUKA KLIZNA ZA LANAC

Šifra	Veličina	Nosivost	A	K	C	Težina
	mm	(T)	(mm)	(mm)	(mm)	(kg)
25177	7/8-8	2	30	91	16	0.36
25178	10-8	3.15	38	115	20	0.73
25179	13-8	5.3	51	145	27	1.40
25180	16-8	8	63	185	31	3.17

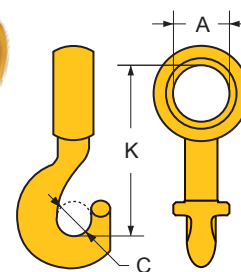

### KUKA ZA LANAC

Šifra	Veličina	Nosivost	A	E	B	H	K	L	Težina
	mm	(T)	(mm)	(mm)	(mm)	(mm)	(mm)	(mm)	(KG)
25151	7/8-8	2	9.5	20	35	28	90	136	0.57
25152	10-8	3.15	13	29.5	46	39.5	127	189	1.4
25153	13-8	5.3	16.5	39.5	59	52	166.5	246	3.0
25154	16-8	8	18.5	46.5	72	59	206	298	5.4

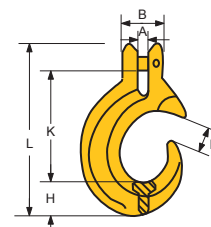

### KUKA ZA LANAC - ŠUMARSKA

Šifra	Veličina	Nosivost	A	K	P	C	T	Težina
	mm	(T)	(mm)	(mm)	(mm)	(mm)	(mm)	(KG)
25191	7/8-8	2	9	66	10	34	19	0.535
25192	10-8	3.15	13	80	12	42	21	0.89
25193	13-8	5.3	16	96	16	54	30	1.75

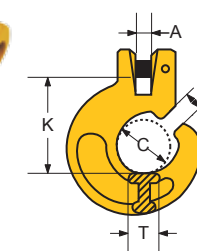

### KUKA ZA TRAKU

Šifra	Nosivost	A	L	W	P	Težina
	(T)	(mm)	(mm)	(mm)	(mm)	(KG)
25198	1.6	54	150	58	30	1.20
25199	2.75	82	194	77	36	2.10

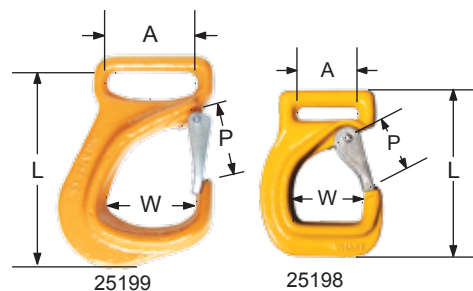

# PRIBOR G 80

## KUKE

### KUKA SA OKOM - OTVORENA

Šifra	Veličina	Nosivost	A	D	P	K	H	T	Težina
	mm	(T)	(mm)	(mm)	(mm)	(mm)	(mm)	(mm)	(KG)
25231	7/8-8	2	18	12	63.5	120	31	25	1.09
25232	10-8	3.15	22	16	76	146	33	32	1.95
25233	13-8	5.3	27	19	89	175	44.5	38	3.22
25234	16-8	8	32	20	101	205	51.5	46	5.26
25235	20-8	12.5	38	25	114	235	65	56	9.07
25236	22-8	15	45	28.5	127	264	68.5	57	11.79

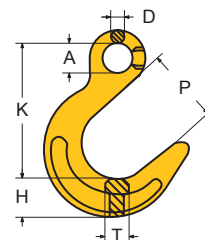

### OVJESNA KARIKA

Šifra	Veličina	Nosivost	A	B	D	E	L	Težina
	mm	(T)	(mm)	(mm)	(mm)	(mm)	(mm)	KG
25311	7/8-8	2	10	32.8	45	87	139	0.53
25312	10-8	3.15	12	42	60	108	174	0.74
25313	13-8	5.3	16.5	55.5	66.5	137.5	228	1.76
25314	16-8	8	19	68	72	165	264	2.8

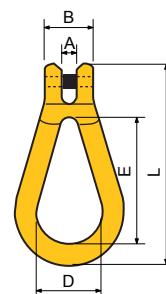

### KONTENJERSKA KUKA

Šifra	Strana	Nosivost	K	A	F	T	G	H	Težina
		(T)	(mm)	(mm)	(mm)	(mm)	(mm)	(mm)	(KG)
25241	Ljeva 45°	12.5	192	70	46	25	75	48	4.0
25242	Desna 45°	12.5	192	70	46	25	75	48	4.0

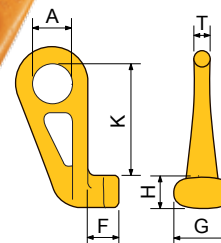

### KUKA "DV"

Šifra	Nosivost	Ø	B	E	H	L	Težina
	(T)	(mm)	(mm)	(mm)	(mm)	(mm)	(KG)
25245	1.5	28	61	3	35	102	0.5
25246	3	30	72	3	41	119	0.73
25247	5	35	84.5	3	42	137	1.2
25248	8	42	96	3	42	153	1.6

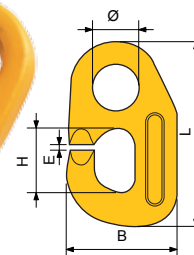

### KUKA ZA NAVARIVANJE

Šifra	Nosivost	A	W	P	T	L	H	F	Težina
	(t)	(mm)	(mm)	(mm)	(mm)	(mm)	(mm)	(mm)	(KG)
25131	2	5	80	25	20	94	24	34	0.84
25132	3	6	115	30	24	105	30	36	1.18
25133	5	10	155	34	28	132	43	44	2.50
25134	8	12	160	34	38	135	51	51	3.26
25135	10	15	200	50	39	167	55	53	5.17

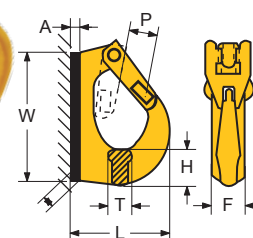



# PRIBOR G 80

## SKRAČIVAČI / OKRETNI VIJCI

### ELEMENT ZA SKRAČIVANJE LANCA SA OSIGURAČEM

Šifra	Veličina	Nosivost	A	M	N	B	L	Težina
	mm	(T)	(mm)	(mm)	(mm)	(mm)	(mm)	(KG)
25175	10-8	3.15	12	56	12	44.5	121	0.99

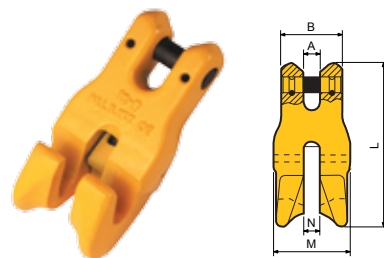

### ELEMENT ZA SKRAČIVANJE

Šifra	Veličina	Nosivost	A	B	C	E	L	Težina
	mm	(t)	(mm)	(mm)	(mm)	(mm)	(mm)	(KG)
25181	6-8	1.12	7.5	7.5	33	26	73.5	0.17
25182	7/8-8	2	9.5	9.5	45	36	101	0.41
25183	10-8	3.15	13	13	55	48	138	0.97
25184	13-8	5.3	18	16	75	59	177	2.01
25185	16-8	8	21	21	93	73	220	3.32
25186	20-8	12.5	22	22	99	78	238	6.2
25187	22-8	15	25.5	25.5	118	98	295	8.5

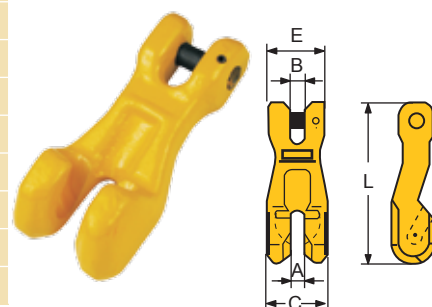

### ALKA ZA BETONSKE BLOKOVE

Šifra	Nosivost	A	B	D	E	F	H	L	Težina
	(t)	(mm)	(mm)	(mm)	(mm)	(mm)	(mm)	(mm)	(KG)
25251	1-1.3	32	42	70.5	45	73	157	181	0.89
25252	1.5-2.5	42	49	85	57	88	190	220	1.3
25253	3-5	55	70	88	69	110	233	271	3.24
25254	6-10	74	92	116	83	161	336.5	386	10.01
25255	12-20	110	114.5	133.5	107.5	182	437	497	20.37

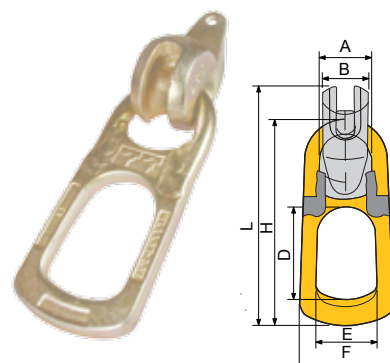

### OKRETNI VIJAK SA ALKOM

Šifra	DxE	Nosivost(T)		B	C	G	T	A	W	Ø	Težina
	(mm)	90°	0°	(mm)	(mm)	(mm)	(mm)	(mm)	(mm)	(mm)	(KG)
25259	M8X13	0.3	0.6	36	15	51	41	55	30	13	0.41
25260	M10X18	0.45	0.9	36	15	51	41	55	30	13	0.43
25261	M12X18	0.5	1.0	36	15	51	41	55	30	13	0.44
25262	M16X20	1.12	2.0	36	15	52	42	55	30	13	0.46
25263	M20X30	2	4	49.5	19	68	56	70	35	16	0.96
25264	M24X30	3.15	6.3	57	22	78	65.5	85	40	18	1.45
25265	M27X35	3.15	6.3	57	22	78	65.5	85	40	18	1.51
25266	M30X35	5.3	10.6	66	23.5	96.5	80.5	85	40	20	2.17
25267	M30X35	8	11.8	80	28	112	92	115	50	22	3.57
25268	M36X50	8	11.8	80	27	109	89.5	115	50	22	3.6
25269	M39X90	8	11.8	80	27	109	89.5	115	50	22	4.10
25270	M42X50	10	15	80	27	109	89.5	115	50	22	3.73

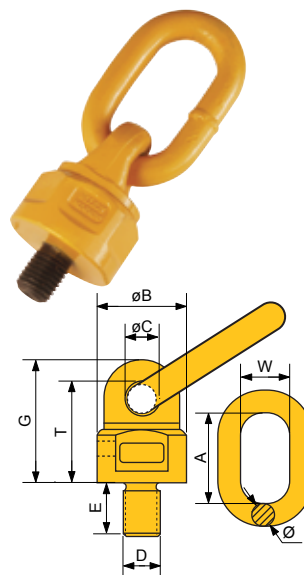

# PRIBOR G 80

## OVJESNE KARIKE

### OVJESNA KARIKA A343

Šifra	Lanac(Ø)		Nosivost (t)	Dimenzije(mm)			Težina kg
	⊥	Λ		A	B	D	
25711	7	6	1.6	110	60	14	0.34
25712	8	7	2.12	110	60	16	0.53
25713	10	8	3.15	135	75	18	0.823
25714	13	10	5.3	160	90	22	1.5
25715	16	13	8	180	100	26	2.32
25716	18	16	11.2	200	110	32	3.95
25717	20	18	14	260	140	36	6.34
25718	22	20	17	300	160	40	8.96
25719	26	22	21.2	340	180	45	12.8
25720	32	26	31.5	350	190	50	16.55
25721	36	32	45	400	200	56	23.28
25722	40	36	56	430	220	63	32

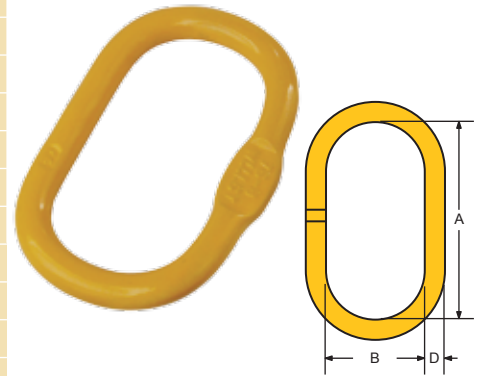

### OVJESNA KARIKA A342

Šifra	Veličina (mm)	Nosivost (t)	Dimenzije (mm)			Težina kg
			A	B	D	
25731	13	3.17	127	63.5	13	0.37
25732	16	4.08	152	76.0	16	0.69
25733	19	5.58	140	70.0	19	0.94
25734	22	6.44	162	95.5	22	1.54
25735	25	11.05	178	89.0	25	2.2
25736	32	16.42	222	111	32	4.34
25737	38	25.67	267	133	38	7.36
25738	44	38.51	305	152	44	11.44
25739	51	46.54	356	178	51	16.8

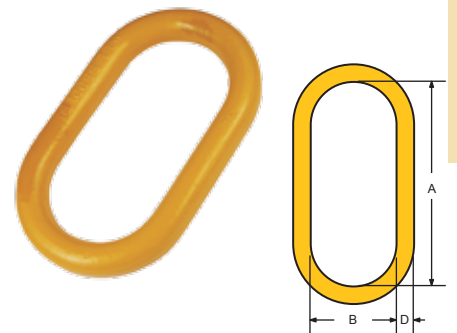

PRIBOR G80

### OVJESNA KARIKA A344

Šifra	Veličina (mm)	Nosivost (t)	Dimenzije (mm)			Težina kg
			A	B	D	
25741	12	1.6	100	60	12	0.27
25742	14	2.76	100	60	14	0.38
25743	18	4	160	90	18	0.85
25744	20	6.5	160	90	20	1.2
25745	22	8.2	180	100	22	1.63
25746	25	11.5	180	100	25	2.13
25747	28	12.8	270	140	28	3.81
25748	32	16	270	140	32	5.05

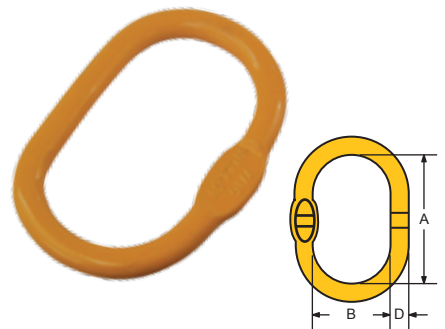



# PRIBOR G 80

## OVJESNA KARIKA

### OVJESNA KARIKA

Šifra	Kod	Nosivost	Dimenzije(mm)					Težina
		T	A	B	D	S	H	KG
25821	13B5	2.6	95	51	13	7	50	0.3
25822	13B6	2.4	115	60	13	7	50	0.35
25823	16B6	3.8	120	70	16	9	70	0.6
25824	16B7	2.8	190	100	16	9	70	0.86
25825	20B6	6.4	150	80	20	11	50	1.1
25826	20B7	5.8	170	90	20	11	70	1.25
25827	22B6	7.6	170	90	22	12	70	1.53
25828	22B7	6.4	210	110	22	12	70	1.83
25829	25B6	10	190	100	25	13	80	2.21
25830	28B6	12.7	210	110	28	15	80	3.06
25831	28B7	10.5	270	140	28	15	70	3.81
25832	32B6	15.2	270	140	32	17	70	5.05
25833	38B6	25.1	270	140	38	20	55	7.3
25834	38B7	17	420	220	38	20	55	10.78
25835	45B6	34	320	170	45	24	60	12.2
25836	45B7	24.5	470	250	45	24	60	17.06
25837	50B6	40	380	200	50	-	-	17.65
25838	60B6	58	430	220	60	-	-	28.85
25839	70B6	84	500	250	70	-	-	45.48

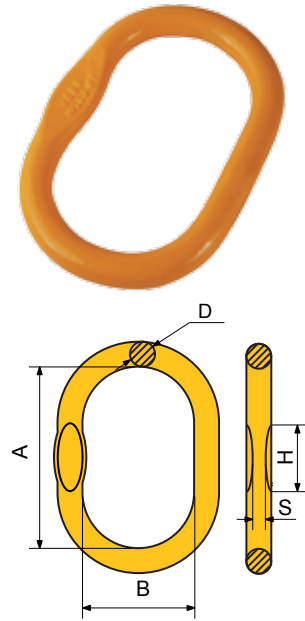

### OVJESNA KARIKA

Šifra	Kod	Nosivost	Dimenzije(mm)			Težina
		T	A	B	D	KG
25841	16B7	3.2	190	100	16	0.86
25842	Y025	6.4	300	210	25	3.53
25843	22B7	7	210	110	22	1.83
25844	Y032	11	300	210	32	5.94
25845	28B7	11.5	270	140	28	3.8
25846	28B6	14.2	210	110	28	3.06
25847	32B6	17	270	140	32	5.05
25848	38B7	19	420	220	38	10.78
25849	38B6	28	270	140	38	7.29
25850	45B7	27	470	250	45	17.06
25851	50B6	45	380	200	50	17.65
25852	60B6	65	430	220	60	28.85

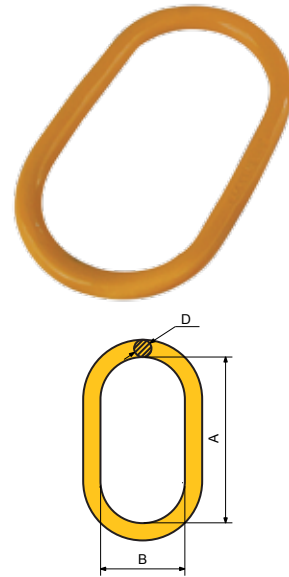

### D - KARIKA

Šifra	Veličina	Nosivost	Dimenzije(mm)			
	mm		t	A	B	C
25761	M8	0.3	38	65	14	26
25762	M10	0.5	38	65	14	26
25763	M12	0.75	38	65	14	26
25764	M16	1	38	85	14	26
25765	M20	2	42	85	16	30
25766	M24	3	46	85	16	32
25767	M30	5	62	114	22	42

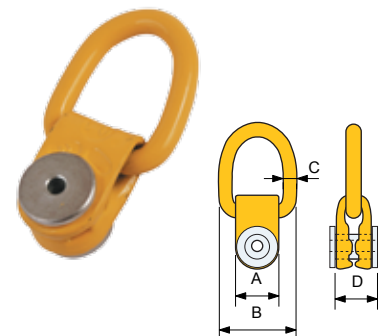

# PRIBOR G 80

## OVJESNE KARIKE U GARNITURI

- Faktor sigurnosti za lanačene priveznice 4:1
- Faktor sigurnosti za priveznice od čeličnog užeta 5:1

### OVJESNA KARIKA U GARNITURI A346

Šifra	Veličina	WLL	B	D	A	b	d	a	Težina
	mm								
25751	6	2.36	75	18	135	25	13	54	1.18
25751A	7	3.15	75	18	135	38	13	60	1.24
25752	8	4.25	90	22	160	34	16	70	2.2
25753	10	6.70	100	26	180	40	18	85	3.4
25754	13	11.20	110	32	200	50	22	115	6.1
25755	16	17	140	36	260	65	26	140	9.98
25756	18	21.2	180	45	340	100	32	180	18.9
25757	20	26.5	190	50	350	100	32	180	22.6
25758	22	31.5	190	50	350	100	36	180	25.2
25759	26	45	200	56	400	110	40	200	34.26
25760	28	50	220	63	430	110	45	200	47.11
25760A	32	63	250	72	460	110	50	200	66.46

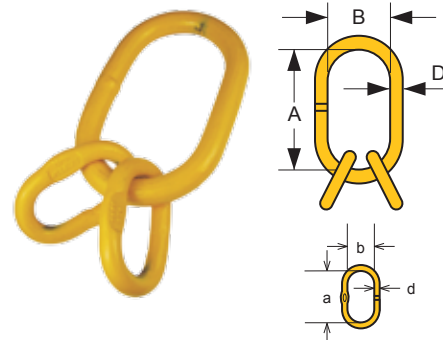

### OVJESNA KARIKA U GARNITURI A345

Šifra	Veličina	Nosivost	B	A	D	a	b	d	Težina
	(mm)								
25781	19	4.1	70	140	20	85	40	14	1.55
25782	25	8.4	89	178	25	100	60	18	3.29
25783	32	14.1	110	220	32	100	60	22	7.18
25784	38	21.3	135	267	38	180	100	28	12.91
25785	44	33.3	152	305	45	180	100	35	21.25
25786	51	40.3	178	356	50	180	100	38	30.34

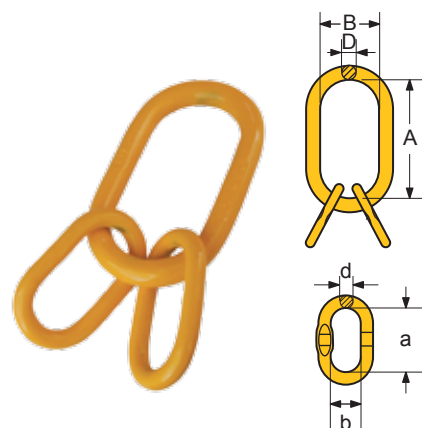

### OVJESNA KARIKA U GARNITURI A347

Šifra	Veličina	Nosivost (t)		D	B	A	d	a	b	Težina
	mm	4:1	5:1							
25791	14	2.4	2	14	60	100	12	85	40	0.82
25792	17	3.2	2.5	18	90	160	14	100	60	1.61
25793	20	5	4	20	90	160	14	100	60	1.95
25794	22	8	6.4	22	100	180	18	150	70	3.16
25795	28	12	9.6	28	140	270	22	160	90	6.75
25796	32	17.4	13.9	32	140	270	25	180	100	9.31

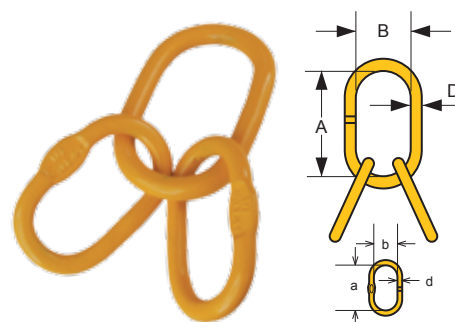

# PRIBOR G 100

## KUKE

### KUKA SAMOZATVARAJUĆA ZA LANAC

Šifra	Veličina (mm)	Nosivost (t)	A (mm)	B (mm)	E (mm)	H (mm)	R (mm)	M (mm)	L (mm)	Težina (KG)
24901	6-10	1.4	7.5	32	28	20	96	70	131	0.5
24902	8-10	2.5	9.5	36	35.5	26	123	90	166	0.9
24903	10-10	4	12	46	45	30	144	109	196.5	1.6
24904	13-10	6.7	15	59	53.5	40.5	182	138.5	251	2.9
24905	16-10	10	17.5	70	62	50.5	217	170.5	303	5.8
24906	20-10	16	25	85	76.5	62	235	192.5	337.5	8.6
24907	22-10	19	25.5	98	80	66	276.5	205	391	12.1

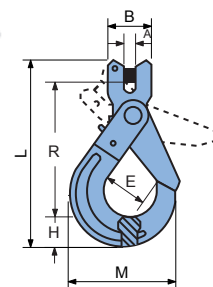

### KUKA SAMOZATVARAJUĆA SA OKOM

Šifra	Veličina (mm)	Nosivost (t)	Ø (mm)	D (mm)	E (mm)	H (mm)	R (mm)	M (mm)	L (mm)	Težina (KG)
24911	6-10	1.4	21	43	28	20	110	70	141	0.5
24912	8-10	2.5	27	51	35.5	26	137	90	175	0.9
24913	10-10	4	34.5	64.5	45	30	169	108	212.5	1.5
24914	13-10	6.7	40	80	53.5	40.5	209	138.5	270	2.7
24915	16-10	10	50	104	62	50.5	254	170.5	331	5.7
24916	20-10	16	60	120	76.5	62	277	192.5	369	7.9
24917	22-10	19	70	134	80	66	319.5	205	417	11.2

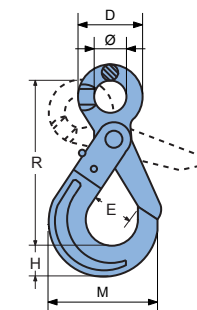

### KUKA SA OKOM I SA OSIGURAČEM

Šifra	Veličina (mm)	Nosivost (T)	d (mm)	E (mm)	h (mm)	Ø (mm)	l (mm)	Težina (KG)
25921	6-10	1.4	10	18.5	21	20.5	111	0.32
25922	8-10	2.5	11	25	27.5	25	137.5	0.6
25923	10-10	4	16	28	33	34	171.5	1.2
25924	13-10	6.7	19	38	43.5	43	219	2.2
25925	16-10	10	24.5	44	50	50	260	3.5
25926	20-10	16	27	52	56	55	298	7.15
25927	22-10	19	29	66	62	60	330	11.5
25928	26-10	26.5	35	73	75	70	367	14
25929	32-10	39.3	39	87	89	66	427	17.5

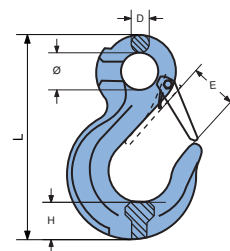

### KUKA ZA LANACA SA OSIGURAČEM

Šifra	Veličina (mm)	Nosivost (t)	A (mm)	B (mm)	E (mm)	H (mm)	M (mm)	L (mm)	Težina (KG)
25931	6-10	1.4	7.5	32	18.5	21	68.5	109	0.33
25932	8-10	2.5	9.5	37	25	27.5	88	134	0.7
25933	10-10	4	12	48	28	33.5	105.5	161.5	1.3
25934	13-10	6.7	15	59	38	42	134	203	2.3
25935	16-10	10	17.5	70	44	50	160.5	246	3.6
25936	20-10	16	25	85	52	56	190.5	297	7.3
25937	22-10	19	27	100	66	62	214.5	326	12.1

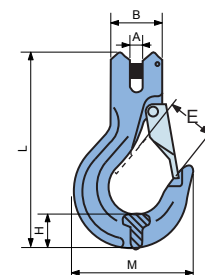

# PRIBOR G 100

## SPOJNICE / SKRAČIVAČI / OVJESNE KARIKE

### SPOJNICA LANCA VG

Šifra	Veličina	Nosivost	H	A	K	L	Težina
	(mm)	t	(mm)	(mm)	(mm)	(mm)	kg
25941	6-10	1.4	7.6	14	44.5	60	0.1
25942	8-10	2.5	10	18.5	61.5	84.5	0.22
25943	10-10	4	12.6	23	72	97.2	0.45
25944	13-10	6.7	16.8	27.5	89	127	1.15
25945	16-10	10	21	33.5	103	145	1.75
25946	20-10	16	24.5	42	116	175	2.7
25947	22-10	19	27	48	135	193	4.02
25948	26-10	26.5	32	61	164	228	5.1
25949	32-10	39.3	40	80	194	274	8.5

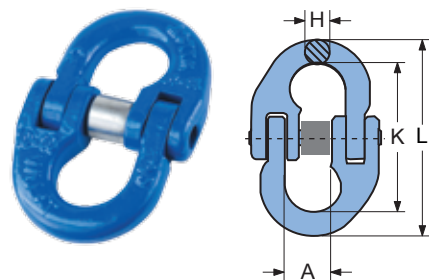

### KUKA ZA SKRAČIVANJE LANCA

Šifra	Veličina	Nosivost	E	Ø	D	M	Težina
	(mm)	(T)	(mm)	(mm)	(mm)	(mm)	(KG)
25951	6-10	1.4	8	14.5	30.5	43.5	0.2
25952	8-10	2.5	10.8	18	37	53	0.28
25953	10-10	4	13.5	22.5	48.5	42	0.72
25954	13-10	6.7	16.5	28	59	96	1.6
25955	16-10	10	19.2	36	74	112.5	2.45
25956	20-10	16	24	43.5	89.5	143	4.72
25957	22-10	19	27	48.5	100.5	160.5	8.2

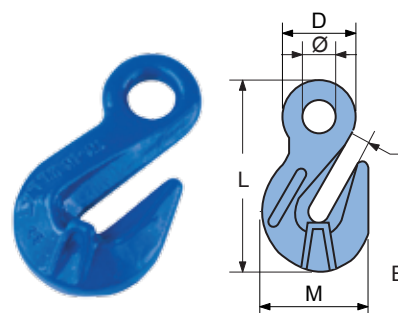

### OVJESNA KARIKA

Šifra	Veličina (mm)	W. L.L. (t)	Dimenzije (mm)			Lanac Ø			Težina kg
			A	B	D	1x	2x	3-4x	
25961	10-10	1.4	80	50	10	5	5	-	0.14
25962	13-10	2.3	110	60	13	6/7	6	5	0.34
25963	16-10	3.5	110	60	16	8	7	-	0.53
25964	18-10	5	135	75	18	10	8	6	0.86
25965	22-10	7.6	160	90	23	13	10	7/8	1.6
25966	26-10	10	180	100	27	16	13	10	2.46
25967	32-10	14	200	110	33	19	16	13	4.14
25968	36-10	25.1	260	140	36	22	19	16	6.22
25969	45-10	30.8	340	180	45	26	22	-	12.85
25970	50-10	40	350	190	50	32	26	19/22	16.55
25971	56-10	60	400	200	60	-	32	26	27.01
25972	72-10	81.5	460	250	70	-	-	32	45

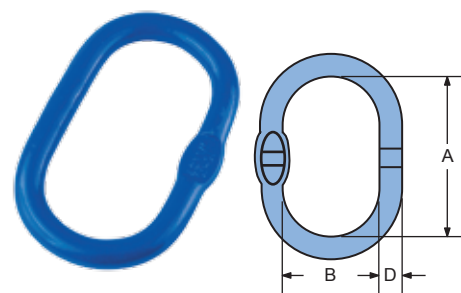

### OVJESNA KARIKA U GARNITURI

Šifra	Veličina (mm)	Nosivost (t)	A (mm)	B (mm)	D (mm)	a (mm)	b (mm)	d (mm)	Težina (KG)
25982	8-10	5.3	160	90	23	70	34	16.5	2.33
25983	10-10	8	180	100	27	85	40	19	3.7
25984	13-10	14	200	110	33	115	50	23	6.5
25985	16-10	21.2	260	140	36	140	65	27	10.1

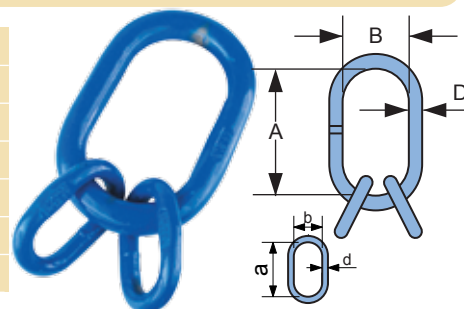

# PRIBOR

## SPOJNICE ZA LANAC

### SPOJNICA LANCA ZA VARENJE

Veličina	Veličina(d) mm	b mm	h mm	m mm
27301	3.5	6.5	17	4
27302	5	9.5	23	6
27303	5.5	10.5	26	4.5
27304	6	10.5	29	7
27305	6.5	11.5	31	7.5
27306	8	15	37	9
27307	9	16.5	38	11
27308	10	19	41	12
27309	12	28	65	17

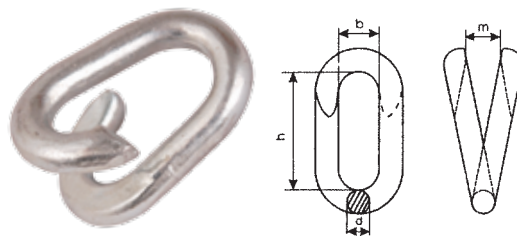

### SPOJNICA LANCA OTVORENA

Materijal: mekani čelik

Završna obrada: ZN ili vruće cinčano

Šifra	Veličina mm	Ø mm	A mm	B mm	Težina kg
27351	10	10	50	16	0.08
27352	12	12	55	18	0.16
27353	16	16	73	22	0.34

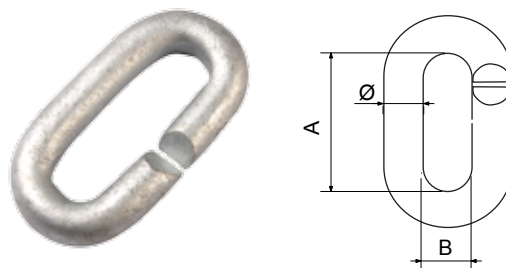

### BRZA SPOJNICA LANCA

Šifra	Veličina(A) mm	L1 mm	L2 mm	F mm
27151	3.5	36	17	5
27152	4	39	19	5.5
27153	5	48	23	6.5
27154	6	57	26	7.5
27155	7	66	30	8.5
27156	8	76	34	10.5
27157	9	83	37	11.5
27158	10	89	40	12.5
27159	12	107	49	14.5
27160	14	121	54	17
27161	16	140	61	19

MATERIJAL: C15

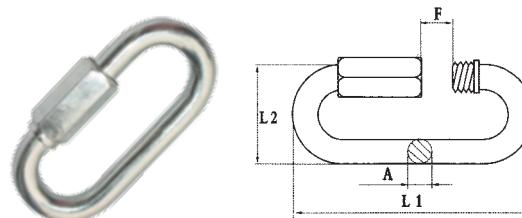

### BRZA SPOJNICA LANCA DUGA

Šifra	Veličina(A) mm	L1 mm	L2 mm	F mm
27181	3.5	47	17	10
27182	5	62	23	14
27183	6	72	26	16
27184	8	90	34	18
27185	10	105	40	20
27186	12	122	48	23

MATERIJAL: C15

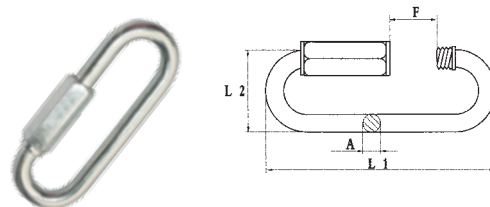

### SPOJNICA LANCA DELTA

Šifra	Veličina mm	ØA mm	L1 mm	L2 mm	F mm	Nosivost LBS
27191	3.5	3.5	37	31	5	120
27192	5	5	47	40	6	450
27193	6	6	56	47	7.5	600
27194	8	8	73	56	10	1100
27195	10	10	87	66	12	1500
27196	12	12	104	75	15	1650
27197	14	14	122	86	19	1900

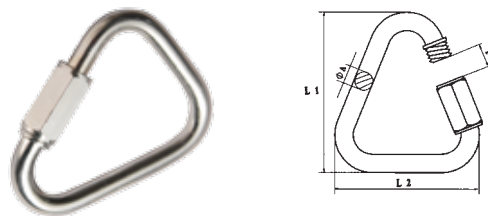

# PRIBOR

## INOX PRIBOR AISI 304 / 316

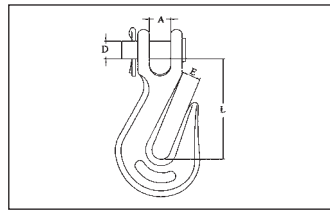

Šifra	Lanac (mm)	Nosivost (T)	D (mm)	A (mm)	E (mm)	L (mm)
25281S	6	0.75	9	11	9	46
25282S	8	1	11	12.5	11	54
25283S	10	1.5	12	15	12	58
25284S	12	2	16	18	16	74

**KUKA SKRAČIVAČ - V**  
AISI:304 / 316

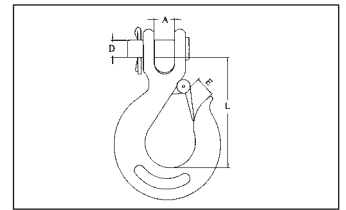

Šifra	Lanac (mm)	Nosivost (Lbs)	D (mm)	A (mm)	L (mm)	E (mm)
25301S	6	1000	9	11	60	15
25302S	8	1500	11	12.5	65	16
25303S	10	2000	12	15	80	18
25305S	12	3000	16	18	87	24

**KUKA ZA LANAC**  
AISI :304 / 316

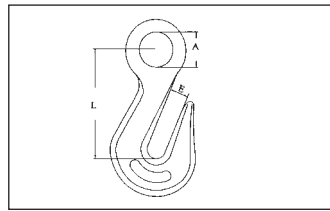

Šifra	Lanac (mm)	Nosivost (Lbs)	A (mm)	E (mm)	L (mm)
25321S	6	1500	13	9	43
25322S	8	2000	16	11	51
25323S	10	2500	18	12	56
25324S	12	3600	23	16	75

**KUKA SKRAČIVAČ - O**  
AISI:304 / 316

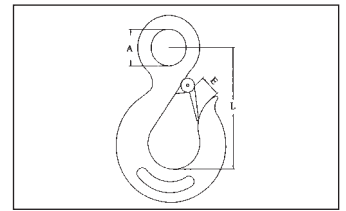

Šifra	Lanac (mm)	Nosivost (Lbs)	A (mm)	L (mm)	E (mm)
25341S	6	1000	13	57	15
25342S	8	1500	16	65	16
25343S	10	2000	18	76	18
25345S	12	3000	23	95	24

**KUKA SA OKOM**  
AISI:304 / 316

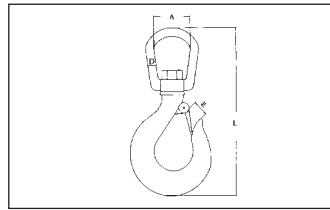

Šifra	Nosivost (lbs)	L	E	D	A
28356S	770	4"	0.67"	0.26"	0.87"
28357S	1430	5"	0.78"	0.32"	1.10"
28358S	2200	6"	0.77"	0.38"	1.10"
28359S	3300	8"	1.18"	0.50"	1.42"

**KUKA OKRETNJA**  
AISI:304 / 316

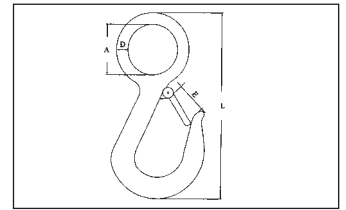

Šifra	Nosivost (T)	A (mm)	D (mm)	L (mm)	E (mm)
28378S	0.3	19	8	100	16
28379S	0.5	28	10	120	22

**KUKA SA VELIKIM OKOM**  
AISI:304 / 316

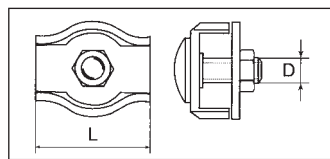

Šifra	Veličina (mm)	L	D
23351S	2	18.5	M4
23352S	3	20	M4
23353S	4	22.5	M5
23354S	5	26	M6
23355S	6	30	M6
23356S	8	36	M8
23357S	10	42	M10

**STEZALJKA SIMPLEX**  
AISI :304 / 316

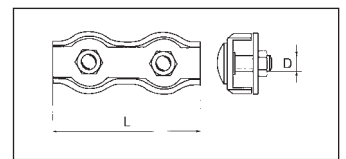

Šifra	Veličina (mm)	L	D
23351DS	2	37	M4
23352DS	3	40	M4
23353DS	4	45	M5
23354DS	5	52	M6
23355DS	6	60	M6
23356DS	8	72	M8
23357DS	10	84	M10

**STEZALJKA DUPLEX**  
AISI:304 / 316

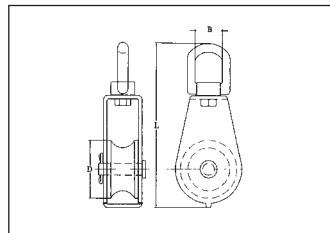

Šifra	Nosivost (T)	D (mm)	Uže (mm)	L (mm)	B (mm)
28307S	0.15	25	6	83	15
28308S	0.25	32	8	97	16
28309S	0.4	50	10	127	20

**KOLOTURA OKRETNJA JEDNOSTRUKA**  
AISI :304 / 316

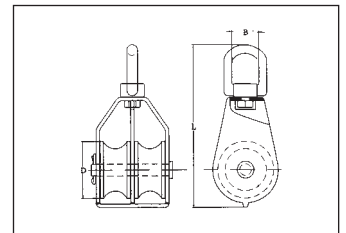

Šifra	Nosivost (T)	D (mm)	Uže (mm)	L (mm)	B (mm)
28375S	0.15	25	6	83	15
28376S	0.25	32	8	97	16
28377S	0.4	50	10	127	20

**KOLOTURA OKRETNJA DVOSTRUKA**  
AISI:304 / 316

PRIBOR



### ŠUMARSKA OMČA, ŠUMARSKI LANAC

- ŠUMARSKA OMČA
- Debljina užeta: 10mm, 12mm, 14mm
- Dužina: po narudžbi

- ŠUMARSKI LANAC
- Debljina lanca: 7mm, 8mm, 10mm
- Dužina: po narudžbi



### KLIZAČI, ČOKERI



KLIZAČ GLAVNOG  
UŽETA "VELIKI"  
RAVNO KOPČANJE



KLIZAČ GLAVNOG  
UŽETA "MALI"  
RAVNO KOPČANJE



KLIZAČ GLAVNOG  
UŽETA  
BOČNO KOPČANJE



KLIZAČ ZA ŠUMARSKE  
OMČE  
"MICRO" I "MIDGET"



KLIZAČI ŠUMARSKOG LANCA



SPOJNICA ZA  
KRPANJE  
TRAKTORSKOG LANCA

# PRIBOR

## ZATEZAČI LANCA - RAČNE

### ZATEZAČ LANCA - RAČNA EN12195-3



Standard :EN 12195-3  
Materijal :lijevano-kaljeno  
Faktor sigurnosti: min. prekidna sila 2 x nosivost  
Završna obrada: crveno lakiran

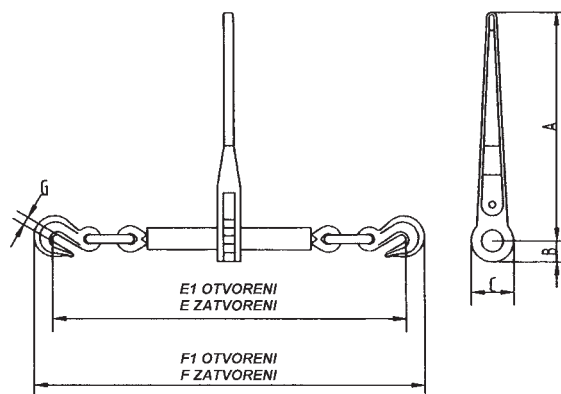

Šifra	Dimenzija lanca	Nosivost	Ispitana sila	Min. prekidna sila	Težina kom	Dužina ručke	Dužina cijevi	Zatezanje	Dimenzije mm							
	mm								kg	kg	kg	kg	mm	mm	mm	A
01351	6	1000	2000	3500	1.60	182	160	118	182	23	45	442	560	488	606	9
01352	8	2500	5000	8600	4.77	341	252	203	354	33	66	605	808	665	868	12
01353	10	4000	8000	15000	5.55	354	252	203	354	33	66	606	809	685	888	16
01354	13	6000	12000	20000	6.54	354	252	203	354	33	66	659	862	752	879	18
01355	16	9000	18000	32000	10.5	354	260	203	354	33	66	735	895	783	941	20

### ZATEZAČ LANCA - RAČNA

- Okretne kuke
- Lijeivano-kaljeno
- Završna obrada: obojeno

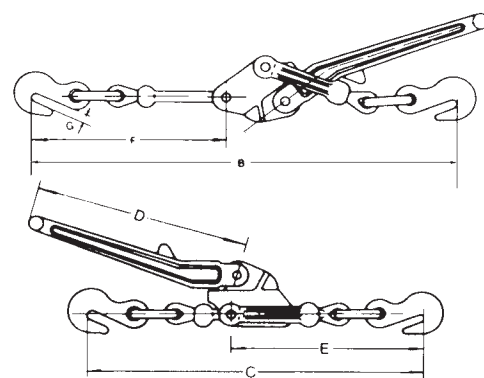

Šifra	Min-Maks. Dimenzija	Nosivost	Ispitana sila	Min. prek. sila	Težina kom	Dužina ručke	Dimenzije (in.)					
	(mm)						(lbs.)	(lbs.)	(lbs.)	(kg)	(in.)	B
01360	8-10	5400	10800	19000	4.17	13.00	23.62	22.32	13.10	11.26	11.26	0.47
01361	10-13	9200	18400	28000	6.86	13.00	26.57	22.08	15.35	12.6	12.2	0.59